



# 3.375 in. HERO® PerFRAC 0.42 in. EH, HMX, PFC-3121-442

## TECHNICAL INFORMATION:

### APPLICATION:

HERO®PerFRAC charges are specifically designed to have consistent entry hole sizes, regardless of gun position, to improve the efficiency of fracturing operations in today's unconventional reservoirs.

### SPECIFICATIONS:

#### NET EXPLOSIVE WEIGHT:

21.5 grams

#### TOTAL CHARGE WEIGHT:

238.2 grams

#### TEMPERATURE RATING:

400°F - 1 hour  
335°F - 24 hours  
310°F - 100 hours

### PACKAGING:

#### QUANTITY PER BOX:

50

#### NET ITEM WEIGHT:

1075 grams

#### NET CHARGE WEIGHT:

11500 grams

#### TOTAL PACKAGE WEIGHT:

12000 grams

#### BOX DIMENSIONS:

14 in. W x 14 in. L x 9 in. D

#### SHELF LIFE:

5 years (left in original packaging)

#### PACKAGE TYPE:

Charges in foil bag with desiccant; inside cardboard box with cardboard spacers

### SHIPPING:

#### CLASSIFICATION:

1.4D

#### DOT NUMBER:

EX1994050290

#### CE NUMBER:

00 80.EXP.01.0032

#### UN NUMBER:

UN0440

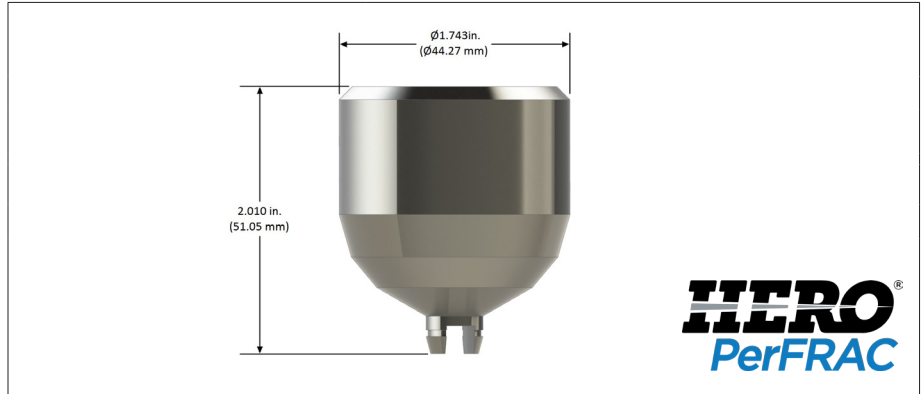

### HOLE SIZE DATA:

CASING	SHOT DENSITY / PHASING	AVG. HOLE SIZE (IN.)	MIN. HOLE SIZE (IN.)	MAX. HOLE SIZE (IN.)	HOLE VARIATION (STDEV)
5.50 in. 20# P-110	6 spf / 60°	0.42	0.40	0.44	3.4%
5.50 in. 23# P-110	6 spf / 60°	0.42	0.40	0.44	4.5%

### PENETRATION DATA - API RP-19B SECTION 2:

FORMATION CORE TYPE	PENETRATION (IN.)	OVERBURDEN (PSI)	UCS (PSI)	POROSITY
Berea	7.50	9500	5717	20.4%
Shale	4.88	9500	19838	6.0%

### SYSTEM TESTED:

3.375 in. 6 spf 60° in 5.50 in. 23# P-110

### DEBRIS DATA - API RP-19B SECTION 5:

Weight of debris lost at detonation	62.67 grams per linear foot
Total weight of debris lost	209.33 grams per linear foot
Volume of total debris lost	95.08 cm <sup>3</sup> per linear foot

### GUN SWELL DATA - API RP-19B SECTION 6:

AIR (IN.)	FLUID (IN.)
3.54 (4 spf)	3.55 (6 spf)